

David White[®]

AL8- Series Owner's Guide



AL8-26

AL8-32

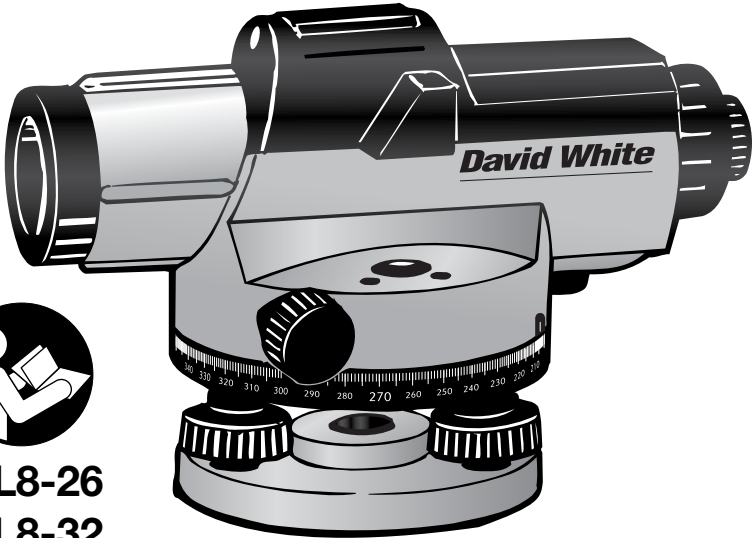

SOLD & SERVICED BY
Survey Instrument Sales

Helping You Measure the World

24037 Acacia Redford, MI 48239 313-535-5252

www.SurveyInstrumentSales.com

**FOR CUSTOMER SERVICE, PARTS
AND REPAIR CALL**

(313) 535-5252

SurveyInstrumentSales.com

IMPORTANT:
Read Before Using

IMPORTANT :
Lire avant usage

IMPORTANTE:
Leer antes de usar

With David White your sights are set on precision and accuracy.

Congratulations! You've purchased a David White builder/contractor instrument, known throughout the world for precision and accuracy.

The purpose of this user's guide is to acquaint you with the instrument, its components, safety, proper care and handling.

Our levels, level-transits and transits are constructed to withstand extremely rugged field use. Like all precision instruments, however, they should be treated with reasonable care to prolong life and accuracy.

All instruments are adjusted when they are shipped from the factory. It is the customer's responsibility to check and to ensure instruments are adjusted prior to using.

David White is not responsible for errors caused by instruments that are out of adjustment.

Contact your distributor, dealer or David White for information on the nearest facility to check if your instrument is properly adjusted.

All specifications are subject to change without notice.

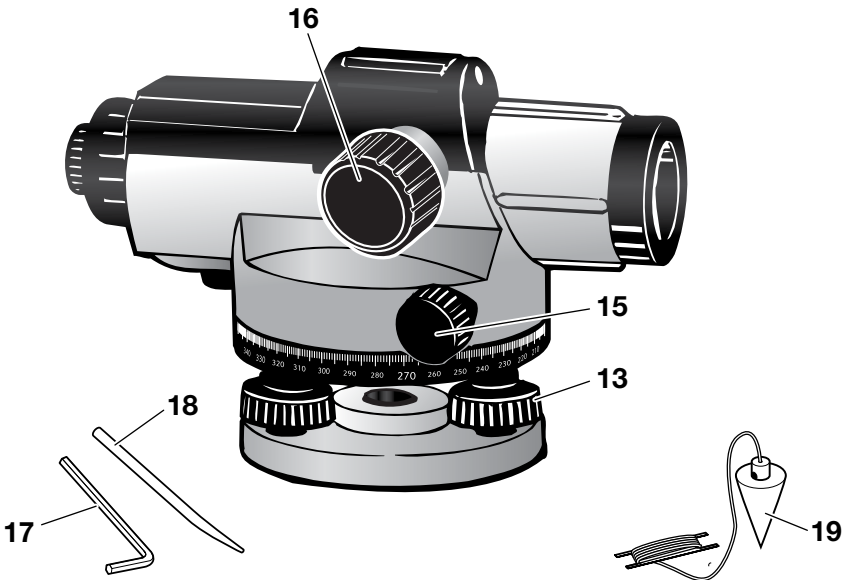
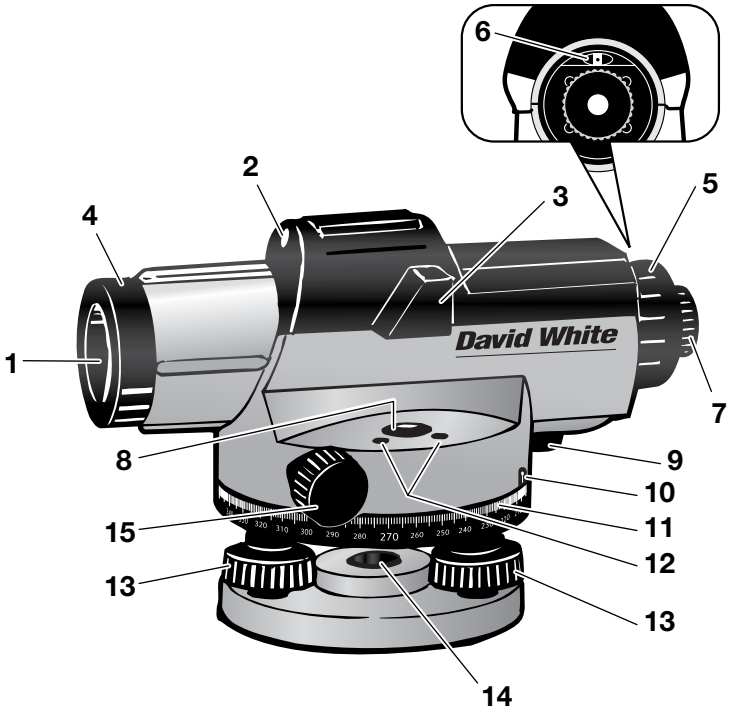

GENERAL SAFETY RULES

⚠ WARNING Read all instructions. Failure to follow all instructions listed below may result in serious injury.

⚠ WARNING When moving a tripod-mounted instrument, handle with care. Carry only in an upright position. Do not carry over your shoulder or in a horizontal position. Improper handling may result in instrument damage

Handle the instrument by its base when removing from the case or attaching to a tripod.

Never use force on any parts of the instrument. All moving parts will turn freely and easily by hand.

Check the leveling and indication accuracy of the instrument each time before using and after longer transport of the instrument.

Protect the instrument against moisture and direct sun light.

Do not subject the instrument to extreme temperatures or variations in temperature.

As an example, do not leave it in vehicles for long time. In case of large variations in temperature, allow the instrument to adjust to the ambient temperature before putting it into operation. In case of extreme temperatures or variations in temperature, the accuracy of the instrument can be impaired.

Avoid any impact to or dropping of the instrument. After severe exterior effects to the instrument, it is recommended to carry out an accuracy check each time before continuing to work.

Place the instrument in the provided case when transporting it over larger distances (e.g. in the car). Ensure that the instrument is correctly placed in the transport case. When placing the instrument in the case.

When carrying instrument, always remove the instrument from the tripod when transporting or carrying it at the jobsite. If the instrument must be carried on the tripod, hold the instrument as vertically as possible and keep it in front of you. Never carry the instrument horizontally over your shoulder.

When transporting instrument long distances, always place in the carrying case.

SAVE THESE INSTRUCTIONS

INTENDED USE

The AL8- series is intended for determining and checking precise horizontal partitions. It is also suitable for measuring heights, distances and angles.

FEATURES

The numbering of the product features shown refers to the illustration of the instrument on the graphic page.

- | | |
|--|---|
| <ul style="list-style-type: none"> 1 Objective lens 2 Optical peep sight 3 Bubble vial mirror 4 Lens sunshade 5 Eyepiece cover 6 Adjusting screw for sighting line 7 Eyepiece 8 Circular bubble vial | <ul style="list-style-type: none"> 9 Compensator lock 10 Horizontal circle reference mark 11 Horizontal circle 12 Adjusting screw of circular bubble vial 13 Levelling screw 14 Tripod mount 5/8" (on the rear side) 15 Horizontal drive screw 16 Focusing knob 17 Allen key 18 Adjusting pin 19 Plumb-bob |
|--|---|

TECHNICAL DATA

AL8-Series	AL8-26	AL8-32
Accuracy:	1/16"@100' (1.6mm at 30m)	1/32"@100' (1.0mm at 30m)
Working Range:	300' (90m)	400' (120m)
Clear obj. aperture:	1.4" (36 mm)	1.6" (40mm)
Setting accuracy:	+/- 0.8"	+/- 0.3"
Deviation for 1 km double-run leveling	1.5 mm	1.0 mm
Telescope:		
Magnification:	26 x	32 x
Image:	Erect	Erect
Length:	8.3" (210 mm)	8.3" (210 mm)
Shortest focusing distance:	1' (0.3m)	1' (0.3m)
Field of view :	1° 30'	1° 30'
Stadia ratio:	100	100
Compensator:		
Leveling range:	±15'	±15'
Magnet dampening:	Yes	Yes
Sensitivity of bubble:	8'/2mm	8'/2mm

Horizontal Circle:

Diameter	4.3" (108 mm)	4.3" (108 mm)
Circle graduation:	1°	1°
Instrument weight:	3.7 lb (1.7kg)	3.7 lb (1.7kg)
Mounting thread:	5/8-11	5/8-11
Protection	IP54	IP54

OPERATION

Initial Operation

Check the leveling and indication accuracy of the instrument each time before using and after longer transport of the measuring tool.

⚠ WARNING Protect the instrument against moisture and direct sun light.

Do not subject the instrument to extreme temperatures or variations in temperature. As an example, do not leave it in vehicles for long time. In case of large variations in temperature, allow the instrument to adjust to the ambient temperature before putting it into operation. In case of extreme temperatures or variations in temperature, the accuracy of the instrument can be impaired.

Avoid heavy impact or falling of the instrument. After heavy exterior impact on the instrument, an accuracy check should always be carried out before continuing to work.

Setting Up Instrument

⚠ WARNING It is important that the tripod is set up firmly.

Make sure that the tripod points are well into the ground. On paved surfaces, be sure the points hold securely.

The legs should have about a 3-1/2 foot spread, positioned so the top of the tripod head appears level.

If using a tripod with adjustable legs, be sure the leg clamps are securely hand tightened.

Attach the instrument to the tripod securely, hand tightening the instrument base to the 5/8-11 tripod head.

Aligning the Instrument

Align the instrument with the levelling screws **13** so that the air bubble is positioned in the centre of the circular bubble vial **8**.

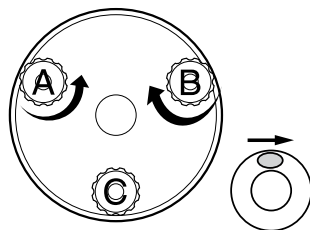

Turn the first two leveling screws **A** and **B** to move the air bubble so that it is centred between the two levelling screws.

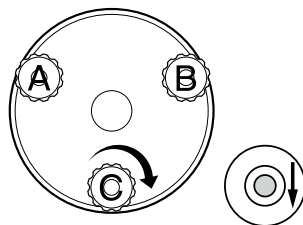

Then turn the third leveling screw **C** until the air bubble is positioned in the centre

of the circular bubble vial.

Any remaining deviation of the instrument to the horizontal plane following the balancing of the circular bubble vial is compensated by means of the compensator.

While working, regularly check (e.g. by viewing through the bubble vial mirror **3**) whether the air bubble is still in the centre of the circular bubble vial.

Setting Up Over a Point

⚠ WARNING Never use force on any parts of the instrument.

All moving parts will turn freely and easily by hand.

Hang the plumb bob **19**, attach cord to the plumb bob hook of the tripod.

Move the tripod and instrument over the approximate point. (Be sure the tripod is set up firmly again. Loosen leveling screws and shift the instrument laterally until the instrument is positioned directly over the point. Align the instrument again.

Focusing the Telescope

Remove the lens cap from the objective lens **1**.

Direct the telescope against a bright object or hold a white sheet of paper in front of the objective lens **1**.

Turn the eyepiece **5** until the crosshair appears sharp and deep black.

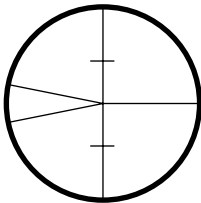

Direct the telescope towards the levelling rod, if required with help of the optical peep sight **2**.

Turn the focusing knob **15** until the graduation field of the levelling rod appears sharp. Align the crosshair exactly with the center of the leveling rod by

turning the horizontal drive screw **14**.

When the telescope is correctly focussed, the crosshair and the image of the levelling rod must remain aligned when moving your eye behind the eyepiece.

Measuring Functions

Always set up the levelling rod exactly vertical. Direct the aligned and focused measuring tool against the levelling rod in such a manner that the crosshair faces centrally against the levelling rod.

Reading the Height

Read off the height of the levelling rod at the centre line of the crosshair.

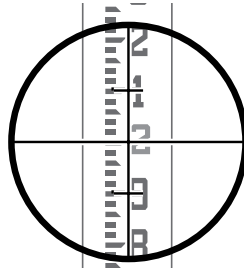

Height measured in the figure: 2.0 ft (1.195 m).

Measuring a Distance

Centre the measuring tool above the point from which on the distance is to be measured.

Read off the height of the levelling rod at the top and bottom stadia lines. Multiply the difference of both heights by 100 to receive the distance from the measuring tool to the levelling rod.

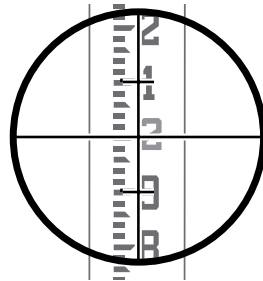

Distance measured in the figure: $(1.347\text{m} - 1.042\text{m}) \times 100 = 30.5 \text{ m}$.

Measuring Angles

Centre the measuring tool above the point from which the angle is to be measured.

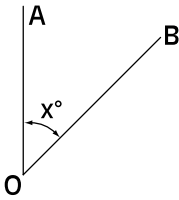

Direct the measuring tool against point **A**.

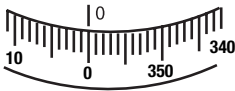

Rotate the horizontal circle **11** with the zero point toward the reference mark **10**.

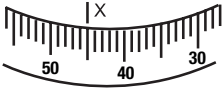

Then direct the measuring tool against point **B**. Read off the angle at the reference mark **10**. Angle measured in the above example: 45°.

Accuracy Check of the Instrument

Check the levelling and indication accuracy of the measuring tool each time before using and after longer transport of the measuring tool.

Checking the Circular Bubble Vial

Align the measuring tool with the levelling screws **13** so that the air bubble is positioned in the centre of the circular bubble vial **8**.

Rotate the telescope by 180°. When the air bubble is no longer in the centre of the circular bubble vial **8**, the circular bubble vial must be readjusted.

Readjusting the Circular Bubble Vial

Bring the air bubble of the circular bubble vial **8** in a position between the centre and the end position of the check by turning the levelling screws **13**.

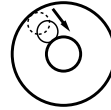

Using the Allen key **17**, turn the adjusting screws **12** until the air bubble is positioned in the centre of the circular bubble vial.

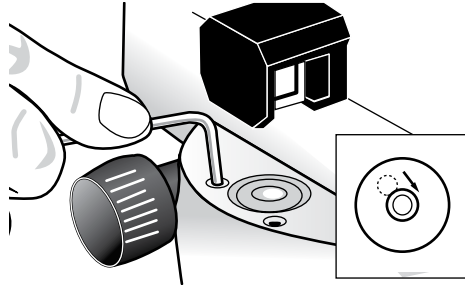

Check the circular bubble vial by rotating the telescope by 180°. If required, repeat the procedure or refer to an authorized SitePro after-sales service.

Checking the Compensator

After aligning and focussing the measuring tool, measure the height at a reference point. Then press the lock button of the compensator **9** and release again. Measure the height again at the reference point.

If both heights do not exactly match, have the measuring tool repaired by an authorized SitePro after-sales service.

Checking the Crosshair

A measuring distance of approx. 100 ft (30 m) is required for the check.

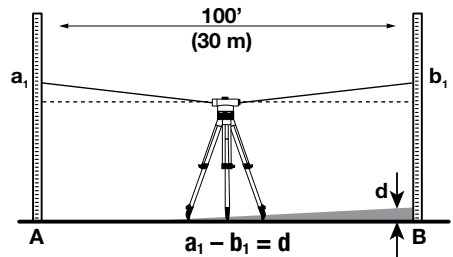

Set up the measuring tool in the centre and levelling rods **A** and **B** at both ends of the measuring distance.

After aligning and focusing the measuring tool, read the heights at both levelling rods. Calculate the difference d between the height a_1 of levelling rod **A** and the height b_1 of levelling rod **B**.

Example:

$$a_1 = 1.937\text{m}$$

$$b_1 = 1.689\text{m}$$

$$a_1 - b_1 = 1.937\text{m} - 1.689\text{m} = 0.248\text{m} = d$$

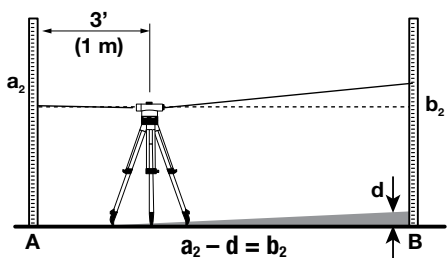

Set up the measuring tool approx. 6 ft (2 m) away from levelling rod **A**. After aligning and focussing the measuring tool, read the height a_2 at levelling rod **A**.

Subtract the previously calculated value d from the measured height a_2 in order to receive the set value for the height b_2 at levelling rod **B**.

Measure height b_2 at levelling rod **B**. When the measured value deviates by more than 3 mm (AL8-26) or 2 mm (AL8-32) from the calculated set value, the crosshair must be readjusted.

Example:

$$a_2 = 1.724\text{m}$$

$$d = 0.248\text{m}$$

$$a_2 - d = 1.724\text{m} - 0.248\text{m} = 1.476\text{m}$$

AL8-26: When measuring, height b_2 must be 1.476 m \pm 3 mm.

AL8-32: When measuring, height b_2 must be 1.476 m \pm 2 mm.

Readjusting the Crosshair

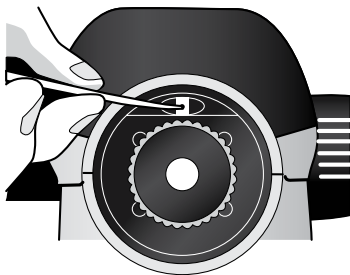

Unscrew the eyepiece cover **5**. Using the adjusting pin **18**, turn adjusting screw 5 clockwise or anticlockwise, until the calculated set value for height b_2 is reached when measuring on levelling rod **B**.

Screw on eyepiece cover **5** again.

MAINTENANCE AND SERVICE

Store and transport the tool only in the supplied protective case.

Keep the tool clean at all times.

Do not immerse the tool into water or other fluids.

Wipe off debris using a moist and soft cloth. Do not use any cleaning agents or solvents.

Regularly clean the surfaces at the exit opening of the laser in particular, and pay attention to any fluff of fibers.

If the tool should fail despite the care taken in manufacturing and testing procedures, repair should be carried out by an authorized after-sales service center for Dave White's SitePro instruments. In all correspondence and spare parts orders, please always include the

model number and serial number of the instruments.

All precision instruments should be cleaned, lubricated, checked and adjusted ONLY at a qualified instrument repair station or by the manufacturer, at least once a year.

In case of repairs, send in the instrument packed in its protective case.

ENVIRONMENT PROTECTION

Recycle raw materials & batteries instead of disposing of waste. The unit, accessories, packaging & used batteries should be sorted for environmentally friendly recycling in accordance with the latest regulations.



LIMITED WARRANTY

Dave White's SitePro ("Seller") warrants to the original purchaser only, that all David White laser tools and optical instruments will be free from defects in material or workmanship for a period of two (2) years from date of purchase.

SELLER'S SOLE OBLIGATION AND YOUR EXCLUSIVE REMEDY under this Limited Warranty and, to the extent permitted by law, any warranty or condition implied by law, shall be the repair or replacement of parts, without charge, which are defective in material or workmanship and which have not been misused, carelessly handled, or misrepaired by persons other than Seller or Authorized Service Center. To make a claim under this Limited Warranty, you must return the complete laser, optical instrument or David White product, transportation prepaid, to SITEPRO Service Department or Authorized Service Center. Please include a dated proof of purchase with your tool. For locations of nearby service centers, please call 1-855-354-9881.

THIS LIMITED WARRANTY DOES NOT APPLY TO ACCESSORY ITEMS SUCH AS TRIPODS, RODS, HAND LEVELS, FIELD SUPPLIES, TAPES, MOUNTING DEVICES AND OTHER RELATED ITEMS. THESE ITEMS RECEIVE A 90 DAY LIMITED WARRANTY.

To make a claim under this Limited Warranty, you must return the complete product, transportation prepaid. For details to make a claim under this Limited Warranty please visit www.davidwhite.com or call 1-855-354-9881.

ANY IMPLIED WARRANTIES SHALL BE LIMITED IN DURATION TO ONE YEAR FROM DATE OF PURCHASE. SOME STATES IN THE U.S., AND SOME CANADIAN PROVINCES DO NOT ALLOW LIMITATIONS ON HOW LONG AN IMPLIED WARRANTY LASTS, SO THE ABOVE LIMITATION MAY NOT APPLY TO YOU.

IN NO EVENT SHALL SELLER BE LIABLE FOR ANY INCIDENTAL OR CONSEQUENTIAL DAMAGES (INCLUDING BUT NOT LIMITED TO LIABILITY FOR LOSS OF PROFITS) ARISING FROM THE SALE OR USE OF THIS PRODUCT. SOME STATES IN THE U.S., AND SOME CANADIAN PROVINCES DO NOT ALLOW THE EXCLUSION OR LIMITATION OF INCIDENTAL OR CONSEQUENTIAL DAMAGES, SO THE ABOVE LIMITATION MAY NOT APPLY TO YOU.

THIS LIMITED WARRANTY GIVES YOU SPECIFIC LEGAL RIGHTS, AND YOU MAY ALSO HAVE OTHER RIGHTS WHICH VARY FROM STATE TO STATE IN THE U.S., OR PROVINCE TO PROVINCE IN CANADA AND FROM COUNTRY TO COUNTRY.

THIS LIMITED WARRANTY APPLIES ONLY TO PRODUCTS SOLD WITHIN THE UNITED STATES OF AMERICA, CANADA AND THE COMMONWEALTH OF PUERTO RICO. FOR WARRANTY COVERAGE WITHIN OTHER COUNTRIES, CONTACT YOUR LOCAL BOSCH DEALER OR IMPORTER.

David White is a registered trademark and distributed exclusively by SitePro.

© Dave White's SitePro 7619 S 1150 E Otterbein, IN 47970
Tel. +1 (765) 581 4097